

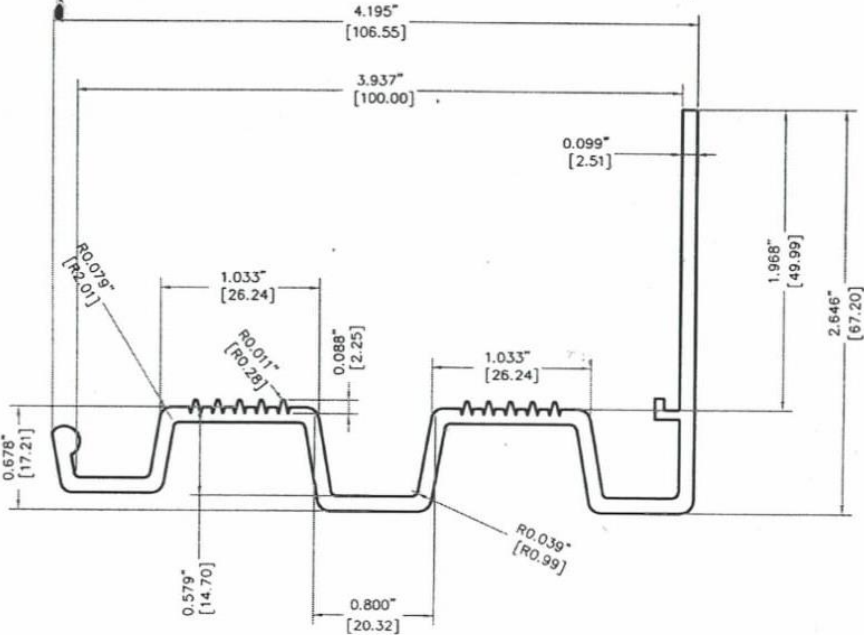





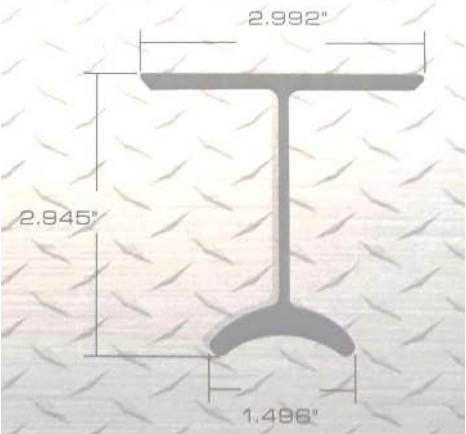

### Perfiles carroceros

Clave	Diseño del perfil	Descripción del perfil	Peso teórico (kg/M)
1003		Piso central 2 muescas	1.279 Kg/M
1004		Piso central 3 muescas	1.786 Kg/M
1001		Piso lateral izquierda	1.493 Kg/M



1002		Piso lateral derecha	1.565 Kg/M
5500		Esquinero	1.683 Kg/M
7785		Rieles carniceros	2.194 Kg/M
6517		Jaladera Paredes: 0.109"	1.407 Kg/M

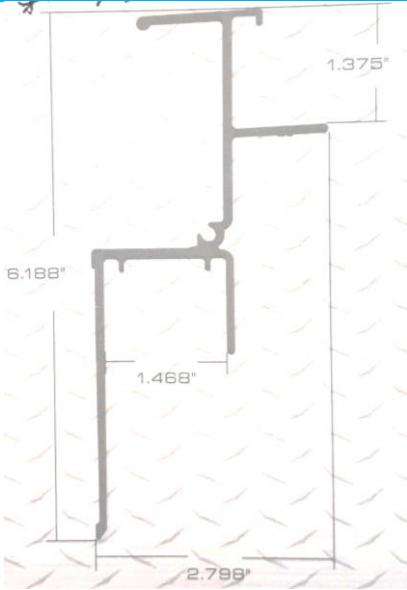

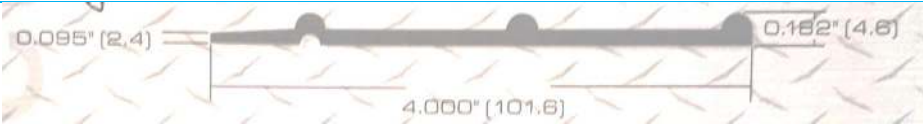
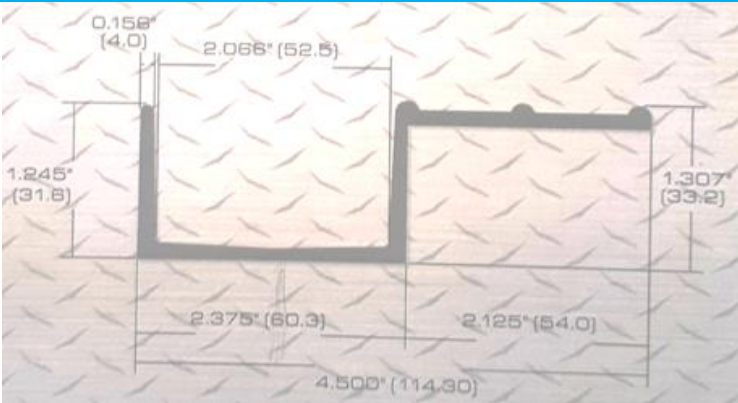
8465		Tableta	0.890 Kg/M
8005		Borda superior	2.072 Kg/M
8604		Borda inferior vista Paredes: 0.120"	1.764 Kg/M
DAI001		Borda inferior vista	0.716 Kg/M
DAI002		Borda superior vista	1.633 Kg/M

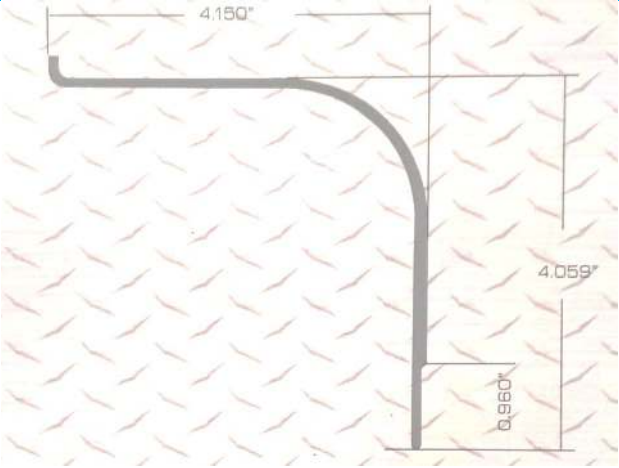
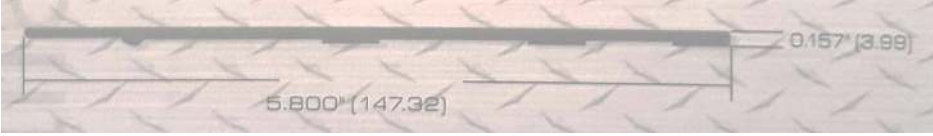
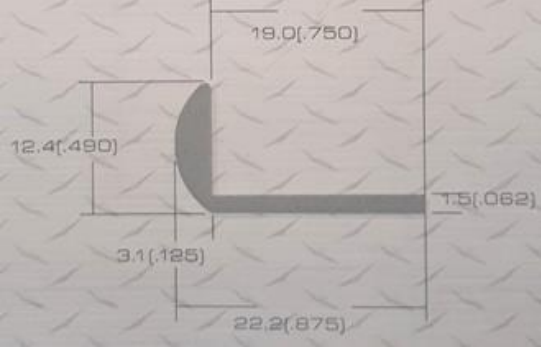
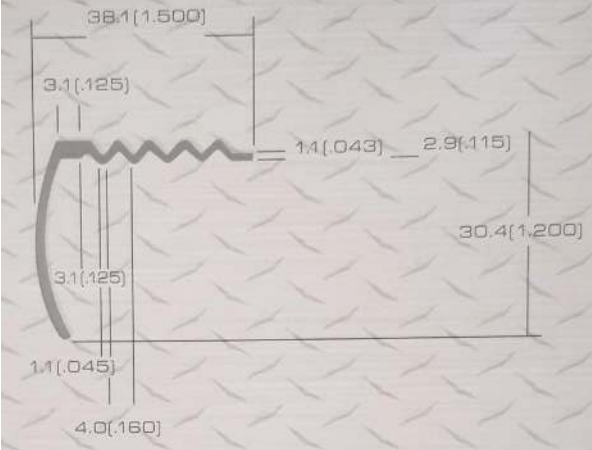

2034		Curva	1.608 Kg/M
8619		Borda vista inferior	1.128 Kg/M
1752		Pecho paloma	0.158 Kg/M
1848		Escalón tipo somex	0.276 Kg/M

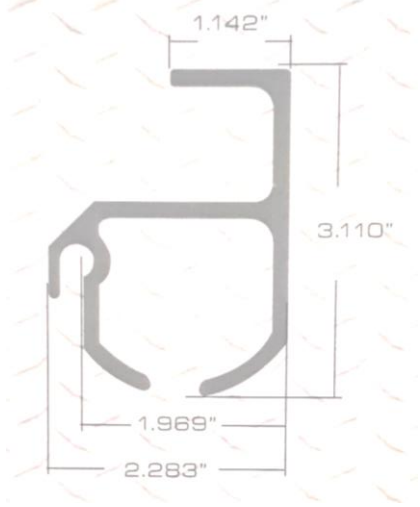

8641		Riel lona	2.498 Kg/M
------	---	-----------	---------------